

FSH 5 STEP LADDER

FSH518 & FSH526

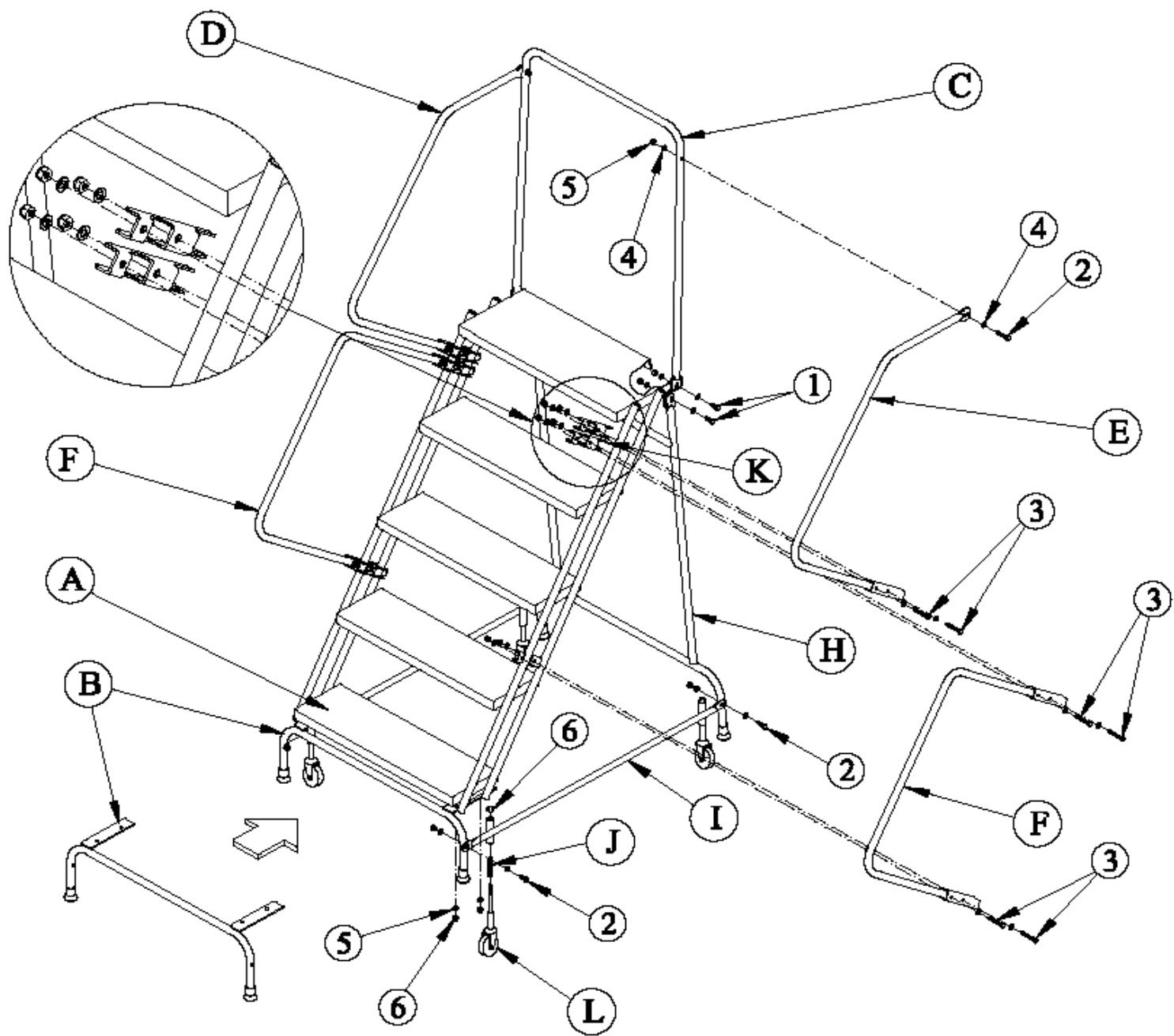

PART #	DESCRIPTION	QUANTITY
A	STAIR SECTION	1
B	FRONT U BAR	1
C	REAR GUARDRAIL	1
D	LEFT TOP RAIL	1
E	RIGHT TOP RAIL	1
F	LOWER HANDRAIL	2
H	VERTICAL WELDMENT	1
I	BASE BRACE	2
J	SPRING	4
K	HANDRAIL BRACKET	6
L	CASTER	4
1	5/16X1" BOLT	2
2	5/16X1_3/4" BOLT	6
3	5/16X2" BOLT	12
4	WASHER	
5	5/16 NYLON LOCKNUT	24
6	CAP LOCKNUT	4

*Washers included in kit & drawing but not mandatory for assembly

3 universal hardware kit. You may have leftover hardware.

FSH

ASSEMBLY INSTRUCTIONS – FSH Ladder

STEP 1 STAIR SECTION

- Place Stair Section (A) on its back.

STEP 2 ASSEMBLE HANDRAIL CONFIGURATION

- Bolt Rear Guardrail (C) to the Top Step using 5/16 x 1" bolts (1) and locknuts (5).
- Connect Top Handrails (D) & (E) to Rear Guardrail (C) using 5/16 x 1 3/4" bolts (2) and locknuts (5).

Note: Handrail stiffener should be positioned on the outside of Stair Section.

- Attach Handrail Bracket (K) to the Top Handrail using 5/16 x 2" bolts (3) and locknuts (5).

Note: Handrail Brackets should be positioned on the inside of Stair Section. Confirm Rear Guardrail (C) is perpendicular to the Top Step and tighten the bolts.

- Mount Lower Handrails (F) using Handrail Brackets (K) and 5/16 x 2" bolts (3) and locknuts (5).

Note: Top of Lower Handrail should butt against Top Handrail.

- Tighten all hardware except where the Rear Guardrail (C) meets the Top Step.

STEP 3 ATTACH VERTICAL WELDMENT

- Turn the assembly over on to the newly assembled Handrails (place protective covering on rough floors to avoid scratching paint).
- Place Vertical Weldment (H) onto back of Stair Section (A). The Vertical Weldment (H) will fit inside the Top Step, using the same bolts as the Rear Guardrail (C).
- Do not over tighten bolts.

STEP 4 ATTACH FRONT U BAR

- Attach Front U Bar (B) to the bottom step using four locknuts (5). Fully tighten.

STEP 5 ATTACH BASE BRACES

- Align Base Braces (I) with the Tabs on the Front Legs and Vertical Weldment (H)
- Use two 5/16 x 1 3/4" bolts (2) and locknuts (5) to fasten the Base Brace (I) to the Front U Bar (B) and Vertical Weldment (H).
- Install the Casters (L) with springs (J) and Cap Locknuts (6) to the Base Braces (I).

STEP 6 FINAL INSPECTION

- Check to see that ladder sits level on floor when standing on the ladder. When testing, please do not climb too high with the hardware not fully tightened. After confirming that ladder sits level, tighten all hardware.