

FS072414 COMPLETE

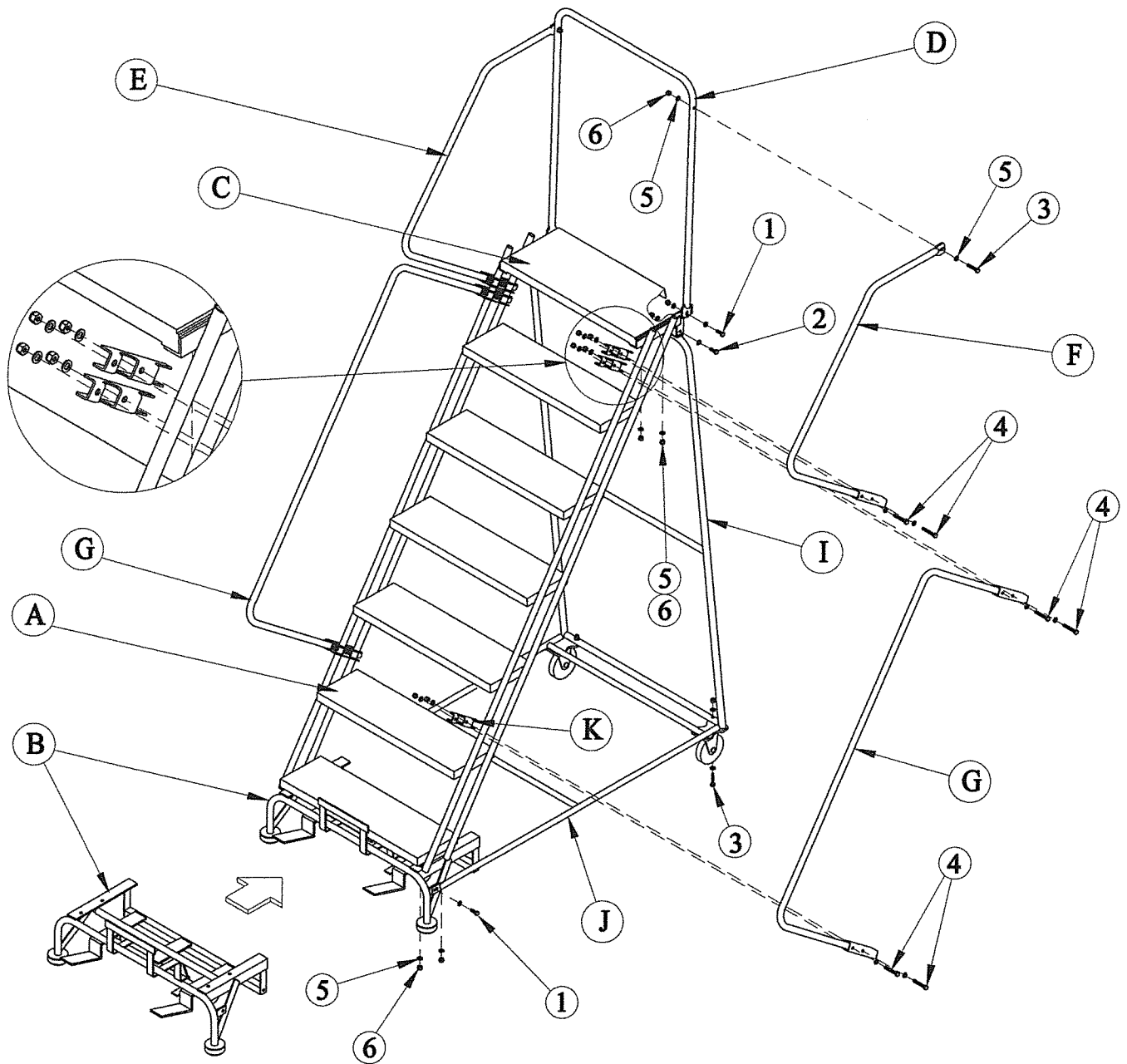

<u>PART #</u>	<u>DESCRIPTION</u>	<u>QUANTITY</u>
A	STAIR SECTION	1
B	LOCKSTEP	1
C	TOP STEP	1
D	REAR GUARDRAIL	1
E	LEFT TOP RAIL	1
F	RIGHT TOP RAIL	1
G	LOWER HANDRAIL	2
I	VERTICAL WELDMENT	1
J	BASE WELDMENT	1
K	HANDRAIL BRACKET	6
<i>1</i>	<i>BOLT M8 x 20</i>	<i>4</i>
<i>2</i>	<i>BOLT M8 x 30</i>	<i>2</i>
<i>3</i>	<i>BOLT M8 x 40</i>	<i>4</i>
<i>4</i>	<i>BOLT M8 x 55</i>	<i>12</i>
<i>5</i>	<i>WASHER 8</i>	<i>52</i>
<i>6</i>	<i>LOCKNUT M8</i>	<i>30</i>

ASSEMBLY INSTRUCTIONS

STEP 1 ASSEMBLE TOP STEP

- Place Stair Section (A) on its' back and attach Top Step (C) using four washers (5) and locknuts (6).

STEP 2 ASSEMBLE HANDRAIL CONFIGURATION

- Bolt Rear Guardrail (D) to the Top Step (C) using M8 x 20 bolts (1), washer (5) and locknuts (6).
- Connect Top Handrails (E) & (F) to Rear Guardrail using M8 x 40 bolts (3), washers (5) and locknuts (6).
Note : Handrail stiffener should be positioned on the outside of Stair Section.
- Attach Handrail Bracket (K) to the Top Handrail using M8 x 55 bolts (4), washers (5) and locknuts (6).
Note : Handrail Brackets should be positioned on the inside of Stair Section. Confirm Rear Guardrail (D) is perpendicular to the Top Step (C), and tighten the bolts.
- Mount Lower Handrails (G) & (H) using Handrail Brackets (K) and M8 x 55 bolts (4) and locknuts (6).
Note : Top of Lower Handrail should butt against Top Handrail.
- Tighten all hardware.

STEP 3 ATTACH VERTICAL WELDMENT

- Turn the assembly over onto the newly assembled Handrails (place protective covering on rough floors to avoid scratching paint).
- Place Vertical Weldment (I) onto back of Stair Section (A) and align brackets on top of Vertical Weldment with Tabs protruding from bottom of Top Step (C).
- Use M8 x 30 bolts (2) with washers (5) and locknuts (6) to fasten Vertical Weldment (I) to Stair Section (A).
- Do not overtighten bolts.

STEP 4 ATTACH LOCKSTEP

- Attach Lockstep (B) to the bottom step using four washers (5) and locknuts (6). Fully tighten.

STEP 5 ATTACH BASE WELDMENT

- Align Base Weldment (J) with the Tabs on the Front Legs of ladder. Note : The casters point up for this alignment.
- Use two M8 x 20 bolts (1) with washers (5), and locknuts (6) to fasten the Base Weldment (J) to the Front Legs.

STEP 6 ATTACH BASE WELDMENT TO VERTICAL WELDMENT

- Unfold Base Weldment (J) and Vertical (I) and align together.
- Use two M8 x 40 bolts (3) with washers (5) and locknuts (6) to assemble the two parts. The bolt is inserted from the bottom of the caster through the hole in the Vertical Weldment (I). Repeat this step on the other side.
DO NOT OVERTIGHTEN!

STEP 7 FINAL INSPECTION

- Check to see that ladder sits level on floor. After confirming that ladder sits level, tighten all hardware.