

154014

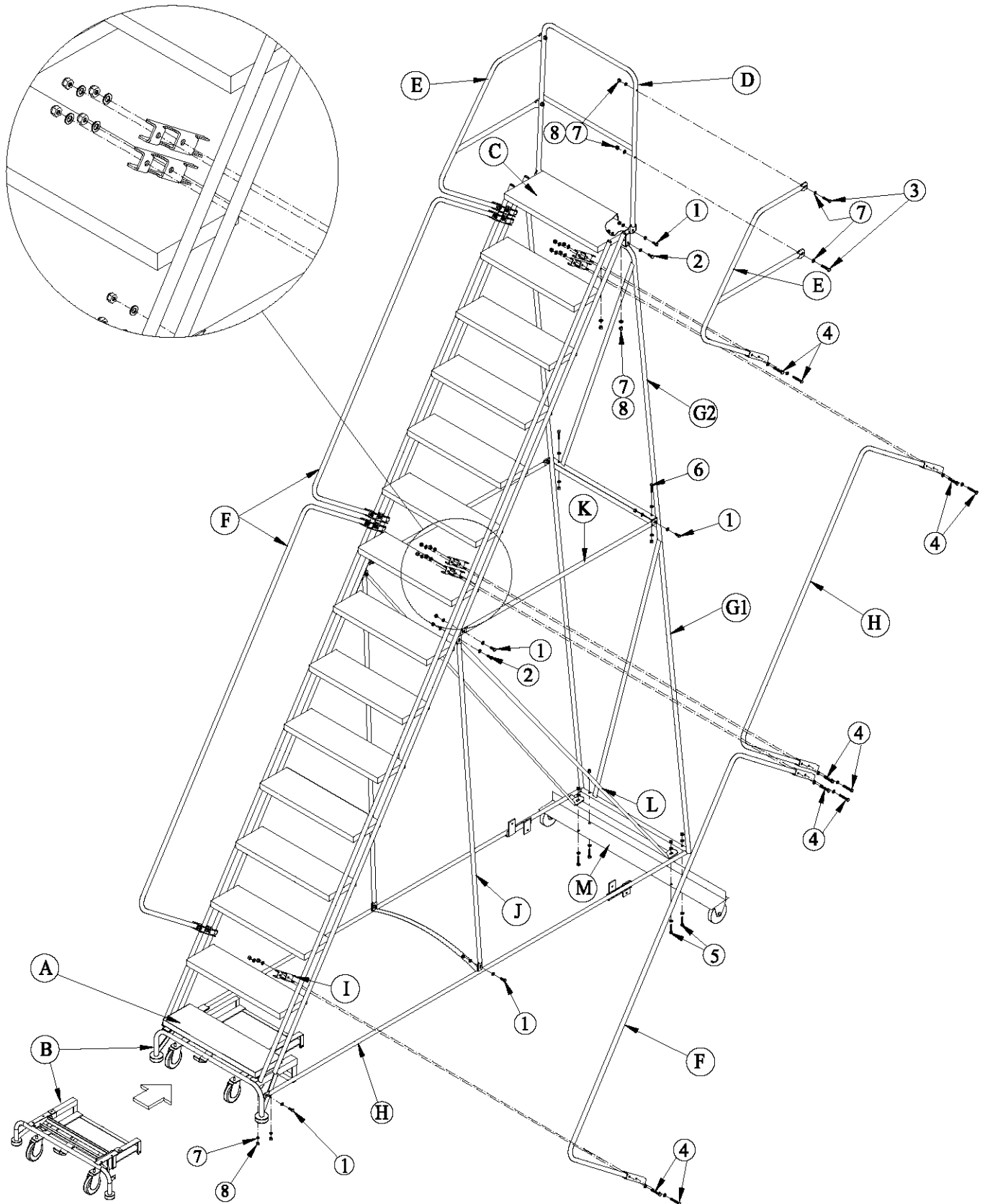

Inspect the ladder for shipping damage prior to starting assembly. If there is evidence of shipping damage notify the carrier immediately.

STEP 1 - ASSEMBLE TOP STEP

- Place Stair Section (A) face down and attach Top Step (C) using four washers (7) and locknuts (8). Tighten bolts completely

STEP 2 - ATTACH LOCKSTEP

- Attach Lockstep (B) to the bottom step using four washers (7) and locknuts (8). Tighten bolts completely.

STEP 3 ATTACH VERTICAL WELDMENT

- Align Lower Vertical Weldment (G-1) & Upper Vertical Weldment (G-2) using M8 x 60 bolts (6) with washers (7) and locknuts (8).
- Place Vertical Weldment (G) onto back of Stair Section (A) and align brackets on top of Vertical Weldment (G) with Tabs protruding from bottom of Top Step (C).
- Use M8 x 25 bolts (2) with washers (7) and locknuts (8) to fasten Vertical Weldment (G) to Stair Section (A).
- Do not tighten bolts.

STEP 4 - ATTACH BASE WELDMENT

- Align Base Weldment (H) with the Tabs on the Front Legs of ladder. Note : The casters point up for this alignment.
- Use two M8 x 20 bolts (1) with washers (7), and locknuts (8) to fasten the Base Weldment (H) to the Front Legs. Do not tighten.

STEP 5 - CONNECT BASE WELDMENT AND REAR VERTICAL WELDMENTS

- Pivot weldments into position so the Angle Steel With Rigid Caster and rear vertical connect. Align the hole in the Angle Steel With Rigid Caster with the hole in the base of the vertical and bolt together using M8 X 50 bolts (5) with washers (7) and locknut(8). Take care not to over tighten.

STEP 6 - INSTALL BRACES

- Install Vertical Braces (J), Horizontal Braces (K) and Diagonal Brace (L) using M8 x 20 bolts (1), M8 x 25 bolts (2) and M8 x 50 bolts (5) with washers (7) and locknuts (8).

If you purchased the All Directional Option install it now, follow the directions included with your kit when complete return to step 7

Get assistance to stand the ladder up. The easiest way to stand the ladder up is to first lay it on it's side. Once the ladder had been stood up take it to a flat surface release the lock step dropping front legs of the ladder to the ground. Make sure the ladder is firmly on the ground and tighten all bolts.

STEP 7- ASSEMBLE HANDRAIL CONFIGURATION – BE CAREFUL WHEN ASSEMBLING HANDRAIL – WE RECOMMEND A SPOTTER TO ASSIST IN THIS STEP

- Bolt Rear Guardrail (D) to the Top Step (C) using M8 x 20 bolts (1), washers (7) and locknuts (8).
- Connect Top Handrails (E) to Rear Guardrail (D) using M8 x 40 bolts (3), washers (7) and locknuts (8). Note : Handrail stiffener should be positioned on the outside of Stair Section (A).
- Attach Handrail Bracket (I) to the Top Handrail using M8 x 55 bolts (4), washers (7) and locknuts (8). Note : Handrail Brackets (I) should be positioned on the inside of Stair Section (A). Confirm Rear Guardrail (D) is perpendicular to the Top Step (C), and tighten the bolts.
- Mount Lower Handrails (F) using Handrail Brackets (I) and M8 x 55 bolts (4) and washers (7), locknuts (8). Note : Top of Lower Handrail should butt against Top Handrail.
- Tighten all hardware.

STEP 8 FINAL INSPECTION

- Check to see that ladder sits level on floor. After confirming that ladder sits level, tighten all hardware. Confirm all bolts have been properly tightened.
- Read instruction manual and become familiar with proper usage and maintenance.
- Connect instruction manual to the ladder, insure all users read important safety information.

PARTS LIST

<u>PART #</u>	<u>DESCRIPTION</u>	<u>QUANTITY</u>
A	STAIR SECTION	1
B	LOCKSTEP	1
C	TOP STEP	1
D	REAR GUARDRAIL	1
E	TOP HANDRAIL	2
F	LOWER HANDRAIL	4
G-1	LOWER VERTICAL WELDMENT	1
G-2	UPPER VERTICAL WELDMENT	1
H	BASE WELDMENT	1
I	HANDRAIL BRACKET	10
J	VERTICAL BRACE	2
K	HORIZONTAL BRACE	2
L	DIAGONAL BRACE	2
M	ANGLE STEEL WITH RIGID CASTER	1
1	<i>BOLT M8 X 20</i>	10
2	<i>BOLT M8 X 25</i>	4
3	<i>BOLT M8 X 40</i>	4
4	<i>BOLT M8 X 55</i>	20
5	<i>BOLT M8 X 50</i>	4
6	<i>BOLT M8 X 60</i>	2
7	<i>WASHER 8</i>	96
8	<i>LOCKNUT 8</i>	52